



Dean Stoves

www.deanforge.co.uk



Handmade
by Craftsmen





Dean Forge

Dean Forge was established by Michael Chew in 1969 in the small village of Dean Prior nestling on the edge of Dartmoor.

Robert Herrick, the Royalist poet was vicar of Dean Prior during the 17th Century and the village is still an attraction for many devotees of his work, much of it written at Dean Prior.

In 1978, when Dean Forge first designed and manufactured woodburning stoves, the very local nature of this business was reflected in the name of the range – Herrick Stoves.

Dean Forge has always been a family run business. Michael, his sons and other dedicated long standing local members of staff have amassed vast expertise and experience in manufacturing and installing wood and multi-fuel stoves.

All Dean Stoves are manufactured at Dean Forge in Devon with the cast iron door cast in a British foundry.

MADE IN BRITAIN



www.deanforge.co.uk

Dartmoor W5

The Dartmoor W5 model has been developed to provide a wide door 5kw stove. An ideal choice for smaller rooms with larger fireplaces.

Dartmoor W5 Features

- Powerful Airwash System.
- Wider Door than the Dartmoor 5, but with same 5kw nominal output.
- Woodburning and Multi-fuel models available.
- **APPROVED** for use in smoke controlled areas with DEFRA kit fitted.
- Kit available to convert the Woodburner model to burn fossil fuels at a later date.
- Rear and Base protection plates not normally required unless the stove is being sited on a heat sensitive hearth material such as Slate or Marble.



Dartmoor W5

CANOPY TYPE	WIDTH	HEIGHT	DEPTH	NOMINAL STOVE OUTPUT	FLUE SIZE	STANDARD LEG LENGTH	EFFICIENCY	FLUE CENTRE TOP (A)	FLUE CENTRE (B)	ENERGY EFFICIENCY CLASS
Profiled Flat Top	565mm	640mm	290mm	5Kw	125mm	105mm	80.6%	103mm	475mm	A+

Dartmoor 5



Dartmoor 5 Features

- The smallest stove from Dean Stoves, yet big on features.
- Powerful Airwash System, designed to create combustion over the glass for a clearer view of the fire helping to clean unwanted deposits from the glass after the fire has been on periods of slumber.
- Woodburner and Multi-fuel models with riddling grate available.
- Kit available to convert the Woodburner model to burn fossil fuels at a later date.
- Base Protection Plate available, helping to reduce the hearth temperature when fitting onto a non-constructural hearth or onto a heat sensitive hearth material e.g. slate or marble.
- Rear Heat Protection Plate can be installed, reducing the safe distance to combustible materials, from the rear of the stove.
- **APPROVED** for use in smoke controlled areas with DEFRA kit fitted.
- Black handle supplied as standard or Stainless Steel option at a small additional cost (see handle options page).

Dartmoor 5

CANOPY TYPE	WIDTH	HEIGHT	DEPTH	NOMINAL STOVE OUTPUT	FLUE SIZE	STANDARD LEG LENGTH	EFFICIENCY	FLUE CENTRE TOP (A)	FLUE CENTRE (B)	ENERGY EFFICIENCY CLASS
Profiled Flat Top	430mm	540mm	285mm	5Kw	125mm	50mm	82%	100mm	435mm	A+

Dartmoor 6&8



Dartmoor 6 & 8 Features

- Large glass door with all the features of the Dartmoor 5 and W5 models
- Powerful Airwash system, designed to create a clearer view of the fire by creating combustion over the glass.
- Woodburner and Multi-fuel models available.
- Optional kit to convert the Woodburner model to burn fossil fuels at a later date.
- Dartmoor 6 approved for use in smoke controlled areas with DEFRA kit fitted.
- Rear and Base protection plates not normally required unless the stove is being sited on a heat sensitive hearth material such as Slate or Marble.

Dartmoor 8 in Mushroom

Dartmoor 6

CANOPY TYPE	WIDTH	HEIGHT	DEPTH	NOMINAL STOVE OUTPUT	FLUE SIZE	STANDARD LEG LENGTH	EFFICIENCY	FLUE CENTRE TOP (A)	FLUE CENTRE (B)	ENERGY EFFICIENCY CLASS
Profiled Flat Top	565mm	640mm	290mm	6.5Kw	150mm	105mm	77.8%	115mm	475mm	A

Dartmoor 8

CANOPY TYPE	WIDTH	HEIGHT	DEPTH	NOMINAL STOVE OUTPUT	FLUE SIZE	STANDARD LEG LENGTH	EFFICIENCY	FLUE CENTRE TOP (A)	FLUE CENTRE (B)	ENERGY EFFICIENCY CLASS
Profiled Flat Top	565mm	640mm	343mm	8Kw	150mm	105mm	74.9%	115mm	475mm	A

Huccaby and Foxworthy High & Low

As part of the Dartmoor range, the Huccaby and the Foxworthy are named after two local beauty spots here in the Dartmoor National Park.

With solid but elegant legs both the Huccaby and Foxworthy carry all the features of the Dartmoor range with the added advantage of an elevated fire. With the presence of a big stove and with lower output, these stoves are ideal for the larger fireplace within a room size that needs 5kw or less. The Foxworthy also has the option of two different leg lengths.



Huccaby



Foxworthy Low

Huccaby Key Features

- 5kw nominal output
- Wood burning or Multi-fuel options
- Powerful Airwash System
- Large glass window
- 80.6% efficient
- Approved for use in smoke controlled areas with a DEFRA kit fitted

Foxworthy Key Features

- 5kw nominal output
- Wood burning or Multi-fuel options
- Powerful Airwash System
- Large glass window
- 82% efficient
- Approved for use in smoke controlled areas with a DEFRA kit fitted



Foxworthy High

Huccaby

CANOPY TYPE	WIDTH	HEIGHT	DEPTH	NOMINAL STOVE OUTPUT	FLUE SIZE	STANDARD LEG LENGTH	EFFICIENCY	FLUE CENTRE TOP (A)	FLUE CENTRE (B)	ENERGY EFFICIENCY CLASS
Profiled Flat Top	565mm	785mm	290mm	5Kw	125mm	250mm	80.6%	103mm	620mm	A+

Foxworthy High

CANOPY TYPE	WIDTH	HEIGHT	DEPTH	NOMINAL STOVE OUTPUT	FLUE SIZE	STANDARD LEG LENGTH	EFFICIENCY	FLUE CENTRE TOP (A)	FLUE CENTRE (B)	ENERGY EFFICIENCY CLASS
Profiled Flat Top	430mm	790mm	285mm	5Kw	125mm	300mm	82%	103mm	688mm	A+

Foxworthy Low

CANOPY TYPE	WIDTH	HEIGHT	DEPTH	NOMINAL STOVE OUTPUT	FLUE SIZE	STANDARD LEG LENGTH	EFFICIENCY	FLUE CENTRE TOP (A)	FLUE CENTRE (B)	ENERGY EFFICIENCY CLASS
Profiled Flat Top	430mm	695mm	285mm	5Kw	125mm	200mm	82%	103mm	588mm	A+

The *Croft* *Clearburn* Range

The Croft Range of Clearburn stoves is designed on simple clean-cut lines and with the added advantage of a flat heating area on top, would grace any home, old or new.

As with all our Clearburn stoves, the substantial double-glazed glass door panel and pre-heat air wash system provide a stove that is more environmentally friendly, burning more of the smoke gases. The Croft Junior, Slimline 5 and Croft Small are approved for use in smoke controlled areas with DEFRA kit fitted.

The Croft Clearburn Range has the option of profiled flat top or rolled edge flat top. Standard is with a black bar handle and black secondary air control knob, but can be ordered with cage or stainless steel bar handles and brass or stainless steel secondary air control knob. See illustrations on option pages.

Croft *Junior*

Key Features

- 5Kw Nominal
- 83% efficient
- Individual Primary & Secondary air controls
- Top and rear flue outlets

Options

- Rear flue adaptor (Backbox)
- Multi-kit with riddling grate
- DEFRA kit (for smoke controlled areas)

Profiled flat top

Croft Clearburn Junior

CANOPY TYPE	WIDTH	HEIGHT	DEPTH	NOMINAL STOVE OUTPUT	FLUE SIZE	STANDARD LEG LENGTH	EFFICIENCY	FLUE CENTRE TOP (A)	FLUE CENTRE (B)	ENERGY EFFICIENCY CLASS
Profiled Flat Top	460mm	635mm	345mm	5Kw	125mm	100mm	83%	100mm	485mm	A+
Rolled edge Flat Top	490mm	635mm	345mm	5Kw	125mm	100mm	83%	100mm	485mm	A+

Croft *Slimline*



Profiled top Slimline 5

The Croft Clearburn Slimline and Small are effectively the same stove, except that the Croft Slimline has a reduced depth. This lowers the KW output but retains the large glass door and wide fire box for maximum view of the fire. Both the Clearburn Small and Slimline 5 are approved to be used in a smoke controlled area with DEFRA kit fitted.

Clearburn Slimline 5

CANOPY TYPE	WIDTH	HEIGHT	DEPTH	NOMINAL STOVE OUTPUT	FLUE SIZE	STANDARD LEG LENGTH	EFFICIENCY	FLUE CENTRE TOP (A)	FLUE CENTRE (B)	ENERGY EFFICIENCY CLASS
Profiled Flat Top	585mm	635mm	330mm	5Kw	125mm	100mm	81.6%	103mm	475mm	A+
Rolled edge Flat Top	622mm	635mm	330mm	5Kw	125mm	100mm	81.6%	103mm	475mm	A+

Croft Clearburn Slimline

CANOPY TYPE	WIDTH	HEIGHT	DEPTH	NOMINAL STOVE OUTPUT	FLUE SIZE	STANDARD LEG LENGTH	EFFICIENCY	FLUE CENTRE TOP (A)	FLUE CENTRE (B)	ENERGY EFFICIENCY CLASS
Profiled Flat Top	585mm	635mm	330mm	6.5Kw	150mm	100mm	79.6%	115mm	475mm	A
Rolled edge Flat Top	622mm	635mm	330mm	6.5Kw	150mm	100mm	79.6%	115mm	475mm	A

Croft *Small*

As with all the Clearburn Range the Croft Clearburn Small 8kw has an exceptional preheated air wash system for a clearer view of the fire.

The Clearburn Range of stoves have an option of either a Rolled Edge flat top or a Profiled flat top and can be used in smoke controlled areas with the DEFRA kit fitted. The Clearburn Small featured here has a Rolled Edge Flat Top.

Rolled edge top Small – also available in profile top see illustrations on options page.

Croft Clearburn Small

CANOPY TYPE	WIDTH	HEIGHT	DEPTH	NOMINAL STOVE OUTPUT	FLUE SIZE	STANDARD LEG LENGTH	EFFICIENCY	FLUE CENTRE TOP (A)	FLUE CENTRE (B)	ENERGY EFFICIENCY CLASS
Profiled Flat Top	585mm	635mm	390mm	8Kw	150mm	100mm	76.4%	115mm	475mm	A
Rolled edge Flat Top	622mm	635mm	390mm	8Kw	150mm	100mm	76.4%	115mm	475mm	A

Croft *Logstore*

The Logstore is part of the stove, elevating the stove for a better view of the fire and creating a wood store below. Working in exactly the same way as all the Clearburn Range the Logstore Clearburns have an extra heat shield below the fire box for added protection for storage of wood.

Available in both the Clearburn Junior and the Clearburn Small.

Approved to be used in a smoke controlled area with DEFRA kit fitted.



Clearburn Small Logstore



Clearburn Junior Logstore

Clearburn Junior Logstore

CANOPY TYPE	WIDTH	HEIGHT	DEPTH	NOMINAL STOVE OUTPUT	FLUE SIZE	STANDARD LEG LENGTH	EFFICIENCY	FLUE CENTRE TOP (A)	FLUE CENTRE (B)	ENERGY EFFICIENCY CLASS
Profiled Flat Top	460mm	850mm	345mm	5Kw	125mm	–	83%	100mm	698mm	A+
Rolled edge Flat Top	490mm	850mm	345mm	5Kw	125mm	–	83%	100mm	698mm	A+

Clearburn Small Logstore

CANOPY TYPE	WIDTH	HEIGHT	DEPTH	NOMINAL STOVE OUTPUT	FLUE SIZE	STANDARD LEG LENGTH	EFFICIENCY	FLUE CENTRE TOP (A)	FLUE CENTRE (B)	ENERGY EFFICIENCY CLASS
Profiled Flat Top	585mm	910mm	390mm	8Kw	150mm	–	76.4%	115mm	745mm	A+
Rolled edge Flat Top	622mm	910mm	390mm	8Kw	150mm	–	76.4%	115mm	745mm	A+

Croft *Medium* & *Large*



Croft Medium with rolled edge top



Croft Medium with profile top

The Croft Medium and Croft Large are the largest output stoves in the Clearburn Range with the powerful Clearburn air wash system and the large double glazed door.

Croft Clearburn Medium

CANOPY TYPE	WIDTH	HEIGHT	DEPTH	NOMINAL STOVE OUTPUT	FLUE SIZE	STANDARD LEG LENGTH	EFFICIENCY	FLUE CENTRE TOP (A)	FLUE CENTRE (B)	ENERGY EFFICIENCY CLASS
Profiled Flat Top	680mm	685mm	490mm	11Kw	150mm	150mm	75.9%	115mm	525mm	A
Rolled edge Flat Top	700mm	685mm	490mm	11Kw	150mm	150mm	75.9%	115mm	525mm	A

Croft Clearburn Large

CANOPY TYPE	WIDTH	HEIGHT	DEPTH	NOMINAL STOVE OUTPUT	FLUE SIZE	STANDARD LEG LENGTH	EFFICIENCY	FLUE CENTRE TOP (A)	FLUE CENTRE (B)	ENERGY EFFICIENCY CLASS
Profiled Flat Top	725mm	685mm	520mm	12.5Kw	150mm	150mm	72.9%	115mm	525mm	A
Rolled edge Flat Top	742mm	685mm	520mm	12.5Kw	150mm	150mm	72.9%	115mm	525mm	A

Clearburn *Double Sided*



Double sided Small with profiled top

Double sided stoves are made to order so delivery times may be longer than our standard production stoves.

Double sided stoves are woodburning only.

Clearburn Double Sided Junior

CANOPY TYPE	WIDTH	HEIGHT	DEPTH TOP	DEPTH O/A	APPROX NOMINAL OUTPUT	FLUE SIZE	LEG	FLUE POSITION	EFFICIENCY	ENERGY EFFICIENCY CLASS
Profiled Flat Top	460mm	635mm	460mm	530mm	8Kw	150mm	100mm	Central	74%	A
Rolled Edge Flat Top	490mm	635mm	460mm	530mm	8Kw	150mm	100mm	Central	74%	A

Clearburn Double Sided Small

CANOPY TYPE	WIDTH	HEIGHT	DEPTH TOP	DEPTH O/A	APPROX NOMINAL OUTPUT	FLUE SIZE	LEG	FLUE POSITION	EFFICIENCY	ENERGY EFFICIENCY CLASS
Profiled Flat Top	585mm	635mm	590mm	650mm	10Kw	150mm	100mm	Central	73%	A
Rolled Edge Flat Top	622mm	635mm	590mm	650mm	10Kw	150mm	100mm	Central	73%	A

Clearburn Double Sided Medium

CANOPY TYPE	WIDTH	HEIGHT	DEPTH TOP	DEPTH O/A	APPROX NOMINAL OUTPUT	FLUE SIZE	LEG	FLUE POSITION	EFFICIENCY	ENERGY EFFICIENCY CLASS
Profiled Flat Top	680mm	685mm	580mm	680mm	12Kw	150mm	150mm	Central	73%	A
Rolled Edge Flat Top	700mm	685mm	590mm	680mm	12Kw	150mm	150mm	Central	73%	A

The Hembury Range

Based on the successful Clearburn Range the Hembury has the same exceptionally efficient air wash system and now with the larger glass window is able to benefit not only from a clearer view of the fire but a view of the whole fire. With clean lines the Hembury Range will adorn any room, traditional or contemporary.



Hembury 5

Hembury 5

CANOPY TYPE	WIDTH	HEIGHT	DEPTH	NOMINAL STOVE OUTPUT	FLUE SIZE	STANDARD LEG LENGTH	EFFICIENCY	FLUE CENTRE TOP (A)	FLUE CENTRE (B)	ENERGY EFFICIENCY CLASS
Profiled Flat Top	460mm	645mm	330mm	5Kw	125mm	100mm	83%	105mm	500mm	A+

Hembury Slimline 5

CANOPY TYPE	WIDTH	HEIGHT	DEPTH	NOMINAL STOVE OUTPUT	FLUE SIZE	STANDARD LEG LENGTH	EFFICIENCY	FLUE CENTRE TOP (A)	FLUE CENTRE (B)	ENERGY EFFICIENCY CLASS
Profiled Flat Top	585mm	645mm	315mm	5Kw	125mm	100mm	81.6%	105mm	485mm	A+

Hembury Range, Features & Options

The Hembury Range of stoves all come with a wood burning plate fitted. This plate enables hot embers to be retained, restricting the air entering the underside of the fire which improves the combustion when burning wood. When burning solid fuel or a mixture of wood and solid fuel together the plate can be easily removed. The Hembury Range of stoves can be ordered with the door handle and air control knobs finished in either black or stainless steel.



Hembury Slimline 5



Hembury 8

Features & Options

- Individual Primary and Secondary air controls
- Top and Rear flue outlets
- Fixed multi-fuel grate and ash pan
- Wood burning plate
- DEFRA kit fitted as standard (for smoke controlled areas, Hembury 5, Slimline 5 & 8)
- Rear vertical flue adaptor (Backbox)
- Closed combustion



Stove top corner detail

Hembury 6

CANOPY TYPE	WIDTH	HEIGHT	DEPTH	NOMINAL STOVE OUTPUT	FLUE SIZE	STANDARD LEG LENGTH	EFFICIENCY	FLUE CENTRE TOP (A)	FLUE CENTRE (B)	ENERGY EFFICIENCY CLASS
Profiled Flat Top	585mm	645mm	315mm	6.5Kw	150mm	100mm	79.6%	115mm	485mm	A

Hembury 8

CANOPY TYPE	WIDTH	HEIGHT	DEPTH	NOMINAL STOVE OUTPUT	FLUE SIZE	STANDARD LEG LENGTH	EFFICIENCY	FLUE CENTRE TOP (A)	FLUE CENTRE (B)	ENERGY EFFICIENCY CLASS
Profiled Flat Top	585mm	645mm	380mm	8Kw	150mm	100mm	76.4%	115mm	485mm	A



Sherford 5

Sherford Slimline 5

Sherford

Woodburning Stove

This clean line modern stove range shares the same technology built into the Dean Stoves Clearburn Range, offering high efficiency and exceptional air wash system, helping to maintain a clearer view of the fire.

The Sherford, named after a new town being built near Dean Stoves, has clean lines and a large glass window for maximum view of the fire. With its stylish modern looks it will enrich any room contemporary or traditional.

Sherford Key Features

- Primary and secondary air controls
- Rear and top flue outlets
- Preheated air wash
- DEFRA kit installed as standard

Sherford Range Options

- Rear vertical flue adaptor
- Closed Combustion



Sherford 5

CANOPY TYPE	WIDTH	HEIGHT	DEPTH	OUTPUT	FLUE SIZE	EFFICIENCY	FLUE CENTRE (A)	FLUE CENTRE (B)	ENERGY EFFICIENCY CLASS
Profiled Flat Top	451mm	645mm	335mm	5Kw	125mm	83%	105mm	500mm	A+

Sherford Slimline 5

CANOPY TYPE	WIDTH	HEIGHT	DEPTH	OUTPUT	FLUE SIZE	EFFICIENCY	FLUE CENTRE (A)	FLUE CENTRE (B)	ENERGY EFFICIENCY CLASS
Profiled Flat Top	576mm	645mm	315mm	5Kw	125mm	81.6%	105mm	485mm	A+

Sherford 8

CANOPY TYPE	WIDTH	HEIGHT	DEPTH	OUTPUT	FLUE SIZE	EFFICIENCY	FLUE CENTRE (A)	FLUE CENTRE (B)	ENERGY EFFICIENCY CLASS
Profiled Flat Top	576mm	645mm	380mm	8Kw	150mm	76.4%	115mm	485mm	A



Sherford 8 with plinth



Sherford 5 with plinth

Sherford

with Plinth

The Sherford 5, Slimline 5 and Sherford 8 now have the option of a plinth fitted below the fire door.

This plinth enhances the stove's clean contemporary lines. The plinth can be purchased with the stove or added at a later date.

For dimensions please see previous page.

Sherford *High*



Sherford 5 High

The Sherford, which was launched in June 2016, has been so successful that Dean Stoves has decided to extend the range. The new Sherford High has been raised on elegant but substantial legs contributing to the contemporary aspect the Sherford emanates.

Sherford 5 High

CANOPY TYPE	WIDTH	HEIGHT	DEPTH	OUTPUT	FLUE SIZE	EFFICIENCY	FLUE CENTRE (A)	FLUE CENTRE (B)	ENERGY EFFICIENCY CLASS
Profiled Flat Top	451mm	810mm	335mm	5Kw	125mm	83%	105mm	500mm	A+

Sherford Slimline 5 High

CANOPY TYPE	WIDTH	HEIGHT	DEPTH	OUTPUT	FLUE SIZE	EFFICIENCY	FLUE CENTRE (A)	FLUE CENTRE (B)	ENERGY EFFICIENCY CLASS
Profiled Flat Top	576mm	810mm	315mm	5Kw	125mm	81.6%	105mm	485mm	A+

Sherford 8

CANOPY TYPE	WIDTH	HEIGHT	DEPTH	OUTPUT	FLUE SIZE	EFFICIENCY	FLUE CENTRE (A)	FLUE CENTRE (B)	ENERGY EFFICIENCY CLASS
Profiled Flat Top	576mm	810mm	380mm	8Kw	150mm	76.4%	115mm	485mm	A

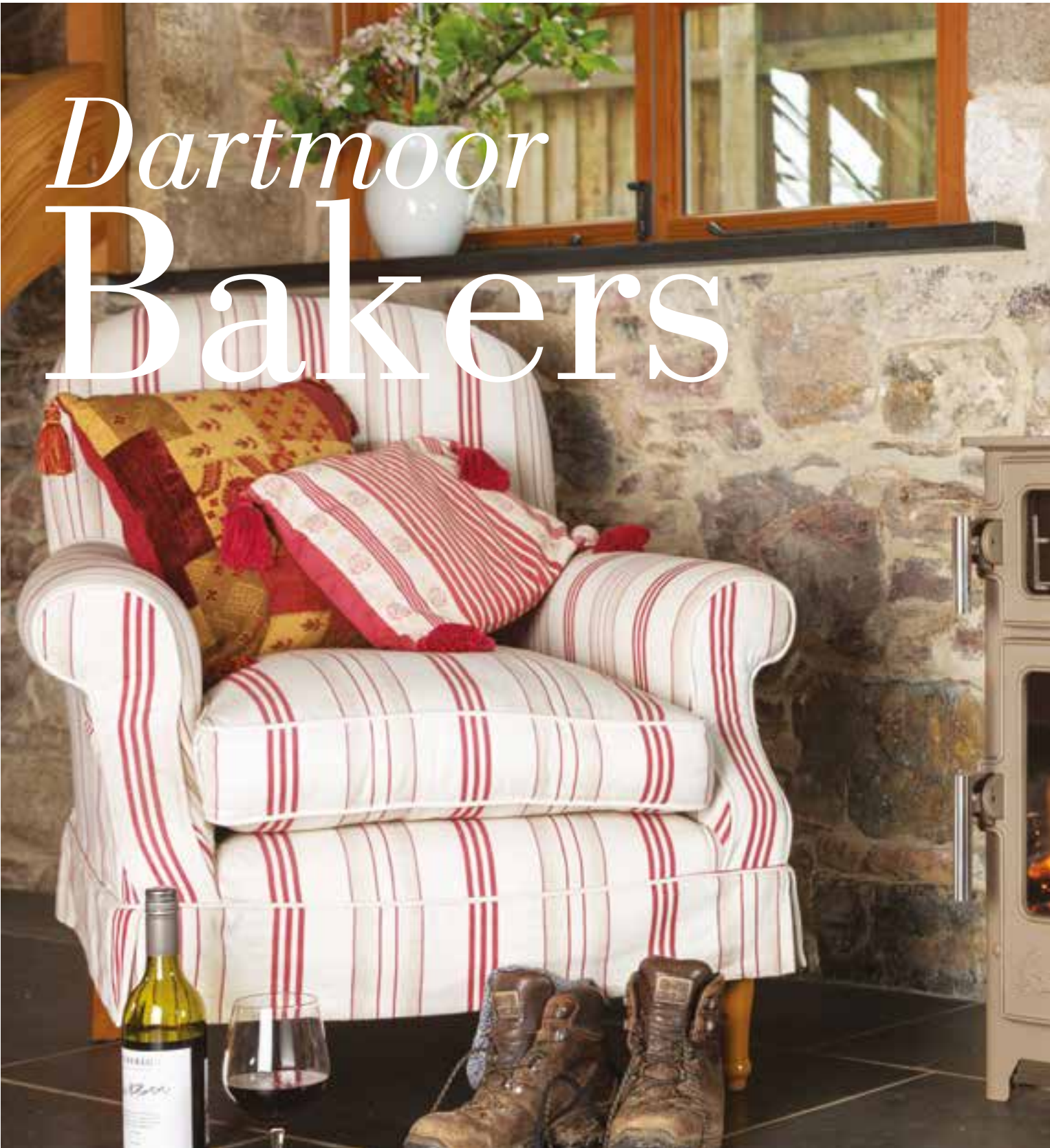

Dartmoor Bakers



Oven Sizes

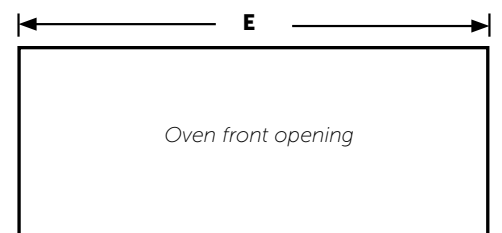
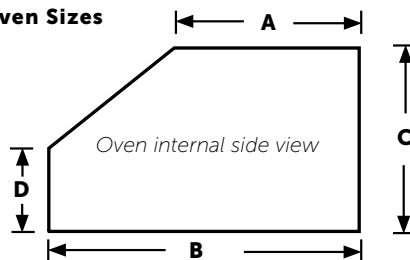

All the Dartmoor Bakers can be manufactured with an extended stove top. The Baker 5 (top width +120mm); Baker W5 (+150mm); Baker 8 (+180mm), and comes as standard on the left handside.

	A	B	C	D	E
Baker 5	155	205	150	100	280
Baker W5	140	205	180	112	410
Baker 8	177	250	180	112	410



Baker 5 in Mushroom

The Dartmoor Baker's (based on the successful Dartmoor Stove Range) have an integral oven above the fire box utilising the heat from the fire to cook bake or warm delicious food.

The Dartmoor Baker comes in three models, the compact Baker 5 (5kw nominal output) the Baker W5 (5Kw Nominal) and the Baker 8 (8kw nominal) all with a good size oven and three shelf heights.

The Dartmoor Baker's have oven vents which allow the cooking smells and condensation to be drawn out of the oven and up the chimney. If you would like to use the top of the stove to warm a pan then the use of the back flue outlet is recommended when installing the stove. Using the rear flue outlet will create a clear area, providing extra space and access to the hotter part of the top plate (near the back), a special Dartmoor Baker back adaptor with flue cleaning access can be purchased to achieve this.

All the Dartmoor Baker's have a removable cleaning plate located inside the oven. This door provides a cleaning access to the top of the oven or for sweeping the chimney when fitted with a top exit flue. Check your chimney sweep is happy to sweep through this access door before installation.

A base plate protector plate is available, helping to reduce the hearth temperature when fitting onto a non-constructural hearth or a heat sensitive hearth material e.g. slate or marble. The Baker 5 must have a base protector fitted when installed on a non-constructural hearth.

The Baker stoves come with stainless steel handles only.

Both the Baker 5 and Baker W5 are approved for the use in smoke controlled areas with a DEFRA kit fitted.



Dartmoor Baker 5

CANOPY TYPE	WIDTH	HEIGHT	DEPTH	OUTPUT	FLUE SIZE	LEG	EFFICIENCY	FLUE CENTRE (A)	FLUE CENTRE (B)	ENERGY EFFICIENCY CLASS
Profiled Flat Top	430mm	720mm	285mm	5Kw	125mm	50mm	82%	100mm	618mm	A+

Dartmoor Baker W5

CANOPY TYPE	WIDTH	HEIGHT	DEPTH	OUTPUT	FLUE SIZE	LEG	EFFICIENCY	FLUE CENTRE (A)	FLUE CENTRE (B)	ENERGY EFFICIENCY CLASS
Profiled Flat Top	565mm	850mm	290mm	5Kw	125mm	105mm	80.6%	103mm	685mm	A+

Dartmoor Baker 8

CANOPY TYPE	WIDTH	HEIGHT	DEPTH	OUTPUT	FLUE SIZE	LEG	EFFICIENCY	FLUE CENTRE (A)	FLUE CENTRE (B)	ENERGY EFFICIENCY CLASS
Profiled Flat Top	565mm	850mm	343mm	8Kw	150mm	105mm	74.9%	115mm	685mm	A

Baker *Plus*

The new Baker Plus range raises the height of the Dartmoor Baker stove creating easier access to the oven.



Baker Plus W5



Baker Plus 5

Please note a DS Cool Wall would have to be used when installing close to a combustible wall.

Baker Plus 5

CANOPY TYPE	WIDTH	HEIGHT	DEPTH	OUTPUT	FLUE SIZE	LEG	EFFICIENCY	FLUE CENTRE (A)	FLUE CENTRE (B)	ENERGY EFFICIENCY CLASS
Profiled Flat Top	430mm	900mm	285mm	5Kw	125mm	50mm	82%	100mm	618mm	A+

Baker Plus W5

CANOPY TYPE	WIDTH	HEIGHT	DEPTH	OUTPUT	FLUE SIZE	LEG	EFFICIENCY	FLUE CENTRE (A)	FLUE CENTRE (B)	ENERGY EFFICIENCY CLASS
Profiled Flat Top	565mm	1000mm	290mm	5Kw	125mm	105mm	80.6%	103mm	685mm	A+

Baker Plus 8

CANOPY TYPE	WIDTH	HEIGHT	DEPTH	OUTPUT	FLUE SIZE	LEG	EFFICIENCY	FLUE CENTRE (A)	FLUE CENTRE (B)	ENERGY EFFICIENCY CLASS
Profiled Flat Top	565mm	1000mm	343mm	8Kw	150mm	105mm	74.9%	115mm	685mm	A

Junior 105Se

The 105Se has had extensive development, now with a fixed multi-fuel grate and separate primary and secondary air controls which give more control when burning wood or smokeless fuel.

With both the primary and secondary air being taken from the base of the stove an external air manifold can easily be installed. This allows you to connect the 105Se's combustion air directly to an outside air duct reducing a possible draught in the room and meeting current building regulations on new houses.*



Junior 105Se High, no lower door

The Junior 105Se incorporates the same, well proven, powerful preheated airwash system as that built in to all our Clearburn Range.



Junior 105Se High with lower door

Key Features

- 5Kw nominal output
- 83% efficient
- Low and high stove options
- Multi-Fuel
- Powerful pre-heated airwash system
- DEFRA approved, suitable for smoke controlled areas
- Large curved glass and door (315mm x 355mm)
- 125mm top and rear flue outlets
- Wood burning plate

Options

- Closed combustion (Direct air inlet facility)
- Optional store door (high model)
- Vertical rear flue adaptor



Junior 105Se Low

Junior 105Se Low

CANOPY TYPE	WIDTH	HEIGHT	DEPTH	NOMINAL STOVE OUTPUT	FLUE SIZE	STANDARD LEG LENGTH	EFFICIENCY	FLUE CENTRE TOP (A)	FLUE CENTRE (B)	ENERGY EFFICIENCY CLASS
Profiled Flat Top	450mm	640mm	375mm	5Kw	125mm	N/A	83%	100mm	485mm	A+

Junior 105Se High

CANOPY TYPE	WIDTH	HEIGHT	DEPTH	NOMINAL STOVE OUTPUT	FLUE SIZE	STANDARD LEG LENGTH	EFFICIENCY	FLUE CENTRE TOP (A)	FLUE CENTRE (B)	ENERGY EFFICIENCY CLASS
Profiled Flat Top	450mm	850mm	375mm	5Kw	125mm	N/A	83%	100mm	698mm	A+

Inset Range

105Se Inset (*Ecodesign Ready*)



The new Junior 105Se inset stove is designed to be installed into a standard fireplace opening with the chair brick removed. With its large curved glass window and powerful airwash system, the 105Se allows a maximum view of the fire.

The 105Se inset has ducting built into all sides of the fire box encouraging cold air to be drawn into the underside of the stove, heated up throughout the ducting and naturally convected into the room through the top and side venting. To further improve control and efficiency when burning wood, the 105Se inset is fitted with the Dean Stoves wood burning plate as standard (this plate must be removed when burning solid fuel). The 105Se inset stove is Ecodesign Ready and satisfies all the stringent emission requirements.

Key Features

- 5Kw nominal output
- Powerful Airwash system
- Large curved glass window
- Multi-Fuel
- Double skin convector box to all sides of the fire box
- DEFRA approved, suitable for smoke controlled areas
- 125mm flue outlet
- Woodburning plate
- Supplied with surround frame for the wider fireplaces

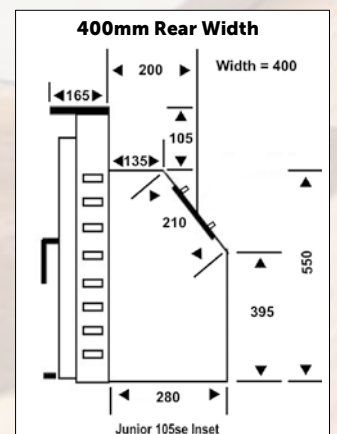

Junior 105Se Inset (Ecodesign Ready)

CANOPY TYPE	WIDTH	WIDTH WITH SURROUND FRAME	HEIGHT	OVERALL DEPTH	NOMINAL STOVE OUTPUT	FLUE SIZE	EFFICIENCY	ENERGY EFFICIENCY CLASS
Profiled Flat Top	450mm	495mm	655mm	450mm	5Kw	125mm	78%	A



Dartmoor 5 *Inset*

The pre-heated air wash system, designed to keep the glass clean and secondary burning of exhaust gases, multi-fuel riddling grate option and superb fuel efficiency make these traditional stoves among the most efficient inset stoves available.

Incorporating all the features of the Clearburn range, these great little inset woodburning or multifuel stoves have been designed to fit into an existing fireplace, often saving on building works to re-model your existing fireplace and hearth depth.



Croft *Inset*



Herrick *Inset*

Key Features

- Incorporating all the features of the Clearburn Range
- Double skin convector
- Preheated airwash system
- Designed to fit into a standard 16" (200mm) fireplace (with fire back removed)
- Handle options. Bar, cage or stainless steel *
- Drop in external riddling multi-fuel grate
- Double glazed heavy cast iron door *
- 5mm steel refractory lined fire box
- 82% efficient
- 5kw nominal output
- 125mm flue outlet

* Croft and Herrick only.

Dartmoor 5 Inset

CANOPY TYPE	WIDTH	HEIGHT	OVERALL DEPTH	NOMINAL STOVE OUTPUT	FLUE SIZE	STANDARD LEG LENGTH	EFFICIENCY	ENERGY EFFICIENCY CLASS
Profiled Flat Top with extra extension frame	495mm	580mm	330mm	5Kw	125mm	-	82%	A
Profiled Flat Top without extra extension frame	480mm	563mm	330mm	5Kw	125mm	-	82%	A

Croft Inset

CANOPY TYPE	WIDTH	HEIGHT	OVERALL DEPTH	NOMINAL STOVE OUTPUT	FLUE SIZE	STANDARD LEG LENGTH	EFFICIENCY	ENERGY EFFICIENCY CLASS
Profiled Flat Top	520mm	563mm	372mm	5Kw	125mm	-	82%	A

Herrick Inset

CANOPY TYPE	WIDTH	HEIGHT	OVERALL DEPTH	NOMINAL STOVE OUTPUT	FLUE SIZE	STANDARD LEG LENGTH	EFFICIENCY	ENERGY EFFICIENCY CLASS
Low Canopy	520mm	622mm	372mm	5Kw	125mm	-	82%	A

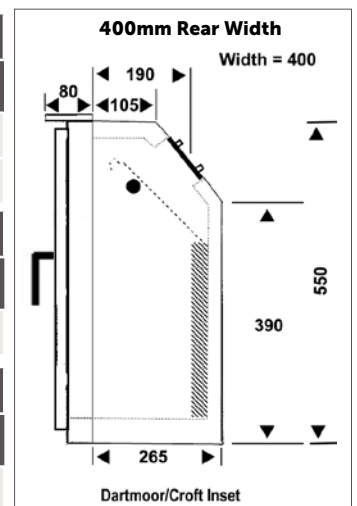



Herrick

Low & High Clearburns



Multi-Fuel grates and three flue options available
– see information page

The Herrick Low Clearburn has the advantage of having a tapered canopy but with a flat heating area on top. As with all our Clearburn stoves, the substantial double-glazed stay-clear glass door panel, plus the pre-heated air wash system, provides a stove that is more environmentally friendly, burning more of the smoke gases.

The Herrick High Clearburn stove has an elegant tapering canopy creating balance in the large Ingenook fireplaces and is used widely in a free-standing installation.

Herrick Low Clearburn

MODEL	WIDTH	HEIGHT	DEPTH	NOMINAL STOVE OUTPUT	FLUE SIZE	STANDARD LEG LENGTH	EFFICIENCY	FLUE CENTRE TOP (A)	FLUE CENTRE (B)	ENERGY EFFICIENCY CLASS
JUNIOR	485mm	720mm	345mm	5Kw	125mm	100mm	83%	100mm	490mm	A
SMALL	610mm	765mm	390mm	8Kw	150mm	100mm	76.4%	115mm	475mm	A
MEDIUM	725mm	820mm	495mm	11Kw	150mm	150mm	75.9%	115mm	525mm	A
LARGE	775mm	820mm	520mm	12.5Kw	150mm	150mm	72.9%	115mm	525mm	A

Herrick High Clearburn

MODEL	WIDTH	HEIGHT	DEPTH	NOMINAL STOVE OUTPUT	FLUE SIZE	STANDARD LEG LENGTH	EFFICIENCY	FLUE CENTRE TOP (A)	FLUE CENTRE (B)	ENERGY EFFICIENCY CLASS
JUNIOR	485mm	825mm	385mm	5Kw	125mm	100mm	83%	100mm	490mm	A
SMALL	610mm	910mm	390mm	8Kw	150mm	100mm	76.4%	115mm	475mm	A
MEDIUM	700mm	962mm	495mm	11Kw	150mm	150mm	75.9%	115mm	525mm	A
LARGE	750mm	962mm	520mm	12.5Kw	150mm	150mm	72.9%	115mm	525mm	A

* Passed smoke control testing. Awaiting certification.

Door Handles & Control Knob Options

The Clearburn Range of stoves come as standard with a black bar handle and black control knob but also have the option of cage or stainless steel handles and brass or stainless steel secondary air control knob. Although we recommend the use of a glove when operating the stove the cage will stay cooler than the black bar or stainless steel handle. Please state which options you would like when ordering your stove.



Black air control knob



Brass air control knob



Stainless steel knob



Black bar door handle



Cage door handle



Stainless steel handle

Dartmoor Handles

The Dartmoor Range of stoves come as standard with a black cast handle or can be ordered with a stainless steel handle, at a small additional cost. All special colour stoves and the Baker stoves will be fitted with stainless steel handles.



DS Cool Wall

A Dean Stove can be installed only 50mm away from DS Cool Wall with a combustible wall behind.

Woodburning stoves have become increasingly efficient, designed to harvest the maximum energy from the fuel and distribute as much heat as possible into the room. With today's building materials and building methods, house walls are designed to be quickly built with high insulation properties. When it comes to installing wood or multi-fuel stoves these materials are often flammable making it unsafe and illegal to install a stove in front or to the side. All CE

tested and approved stoves will have gone through an over fire test, often bringing the stove to a point where it will glow red hot. This test will determine how far from combustible materials the stove can be installed. Some stove companies will restrict the primary and secondary combustion air to reduce the heat produced on this test, but this can impede the performance of the stove.

Dean Stoves have decided not to restrict the combustion air and have developed the DS Cool Wall. Under test the DS Cool Wall recorded temperatures of more than 600°C behind the stove with a rise in room temperature behind the DS Cool Wall of only 4°C.

The DS Cool Wall comes in high temperature Black.



DS Cool Wall

MODEL	WIDTH	HEIGHT	DEPTH
LARGE	1200mm	1100mm	80mm
SMALL	900mm	1100mm	80mm

Information & Options

Clear Vision of Fire

Dean Clearburn, Hembury, Sherford and 105Se stoves incorporate a preheated air wash system. This system is designed to heat the secondary air to a very high temperature before being drawn over the glass.

The stove induces pre-heated air from the bottom of the stove through a labyrinth of passages into the top of the stove and over the glazed door, this drives unburnt gases back into the fire chamber mixing with the air at the same time.

These gases combined with the hot air cause combustion over the glass, burning more fuel particles and unwanted deposits off the glass; thus increasing the efficiency and vision of the fire.

Legs

All Junior, Slimline and Small Clearburn stoves are fitted with 100mm legs and all Clearburn stoves in the medium and large ranges are fitted with 150mm legs as standard giving their standard height in the tables.

Airwash Systems

The Hembury, Clearburn, 105Se and Sherford range of stoves have airwash systems unlike many other stoves on the market. The secondary air is taken in through the base of the stove where it starts to take on heat; it then continues on a journey through special air ducting inside the stove, where it is heated to a very high temperature before entering the fire box. This superhot air causes combustion over the glass, burning smoke particles and unwanted deposits off the glass.

Flue Options

There are three flue arrangements available – top, rear and back box.

Top and rear flue options are fitted as standard on all Dean Stoves. This is achieved by moving the interchangeable flue spigot and cover plate to either the top or the back.

The back box (see illustration) is an optional extra, this is fixed to the back outlet on the stove, using the same fixing point as the standard spigot, and enabling the stove to be brought forward in the fireplace and the top kept clear, whilst using a vertical flue. This option also eliminates the use of a tee and cap, with the added facility in most cases to still clean the flue through the stove.

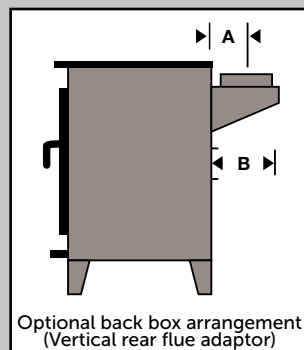

Optional back box arrangement
(Vertical rear flue adaptor)

Dimension A	Dimension B
125mm outlet 90mm	125mm outlet 180mm
150mm outlet 105mm	150mm outlet 210mm

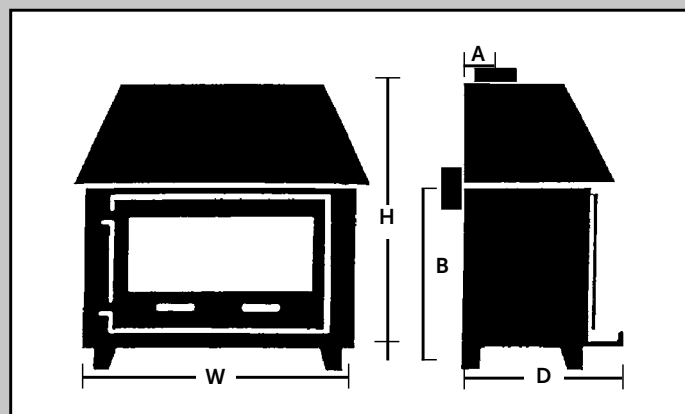

Multi-Fuel Grates Option

The full range of Clearburn stoves can be fitted with a multi-fuel coal grate, except in the double-sided stoves. The Junior, Slimline and Small can be fitted with a grate system where you can riddle the ash through to an ash pan via an external riddling arm. The Medium and Large stoves have a static grate system. The Hembury and 105Se Range are all fitted with a multi-fuel grate and a removable wood burning plate as standard.

Hearth Requirements and Stove Installation

All Dean Stoves and the Dartmoor 5 / Baker 5 with the base protector fitted can be sited on a minimum of 12mm of non combustible hearth to meet current building regulations. Please refer to installation instructions and current building regulations before installing your stove.

Dean Stoves recommend all stove installations are carried out by an experienced HETAS qualified engineer.

Stove Finish

Stoves are finished with a high quality heat resistant paint. Flat black is our standard colour for all of our stoves. A range of colours (see opposite page) are available on all stoves *except* the Clearburn range.

Fuel

All stoves will burn wood, peat and brickettes. Stoves fitted with multi-fuel grates will burn all types of smokeless fuel recommended for enclosed appliances.

As with all woodburning stoves the wood you burn must have a moisture content of less than 20%. It is imperative the wood you use should have at least one year's air drying in a covered position before use on any stove.

Closed Combustion

The Clearburn Range (woodburning only), Sherford, Hembury and 105Se (wood and multi-fuel) can be fitted with a direct air manifold enabling combustion air to be connected directly to an outside air source.

By using the Closed Combustion system you prevent the stove from stealing heat from the room thus maximising the heat efficiency of the stove.

To calculate heat requirement for your room

A good rule of thumb guide to calculate the heat requirement of a given room is:

$$\begin{aligned} & \text{HEIGHT} \\ & \times \\ & \text{WIDTH} \\ & \times \\ & \text{DEPTH (in feet)} \\ & + \\ & \mathbf{500} \text{ (for metres divide by 14)} \end{aligned}$$

This gives you the kilowatt requirement. Multiply this result by 3,400 to get the BTU's requirement.

This is based on average house insulation with room temperatures of 20°C and an ambient temperature of -1°C.

Well-insulated houses could replace the division of 500 with 650.

Distance to combustibles (mm)

Stove	Rear of Stove	Side of Stove	With rear heat shield
Hembury 5	700	600	-
Clearburn Junior	700	600	-
Sherford 5	700	600	-
Junior Logstore	700	600	-
Junior 105Se	700	600	-
Hembury Slimline 5	1000	500	400
Clearburn Slimline 5	1000	500	400
Sherford Slimline 5	1000	500	400
Hembury 6	850	700	-
Clearburn Slimline 6	850	700	-
Hembury 8	850	700	-
Clearburn Small	850	700	-
Sherford 8	850	700	-
Clearburn Small Logstore	850	700	-
Clearburn Medium	1000	700	-
Clearburn Large	1200	800	-
Clearburn Junior Double Sided	n/a	800	-
Clearburn Small Double Sided	n/a	950	-
Clearburn Medium Double Sided	n/a	950	-
Dartmoor 5	950	750	500
Foxworthy	950	750	500
Dartmoor W5	900	600	475
Dartmoor 6	900	600	475
Huccaby	900	600	475
Dartmoor 8	900	600	475
Dartmoor Baker 5	950	750	500
Dartmoor Baker W5	900	600	475
Dartmoor Baker 8	900	600	475

Inset Stoves	Rear of Stove	Side of Stove	Above Stove
105Se Inset	n/a	200	400
Clearburn Inset	n/a	250	250
Dartmoor Inset	n/a	250	250

Croft Clearburn Top Options

All Croft Clearburn stoves have the option of a profiled flat top or a rolled edge flat top. As with all the Clearburn range, options of cage, bar or stainless steel handle and black, brass or stainless steel secondary air control knobs are available. See illustration page.



**Croft Clearburn Junior
with profile top**



**Croft Clearburn Junior
with rolled edge top**

Available colours



Aubergine



Grey



Champagne



Charcoal



Dory Blue



Firecracker Red



Honey Glow Brown



Mushroom

Please note

All heat resistant paint will change colour shades when the stove is put under fire and the paint is fully cured. Some of the lighter colours will noticeably vary in shade where the stove naturally has cooler areas, the Dartmoor Baker is one such stove.

The Clearburn Range is restricted to a colour choice of Charcoal, Dory Blue, Honey Glow Brown and Grey.

Due to the limitations of the print process actual colours may vary. Stoves in this brochure photographed on Dartmoor may appear lighter due to the outdoor lighting conditions.

Dean Stoves would like to thank Leighon Estates for permission to photograph the stoves at Hound Tor, Dartmoor and all the customers that have allowed us into their homes to photograph their installed Dean Stoves.



Dean Forge



Dean Forge Fabrications Ltd

Dean Prior, Buckfastleigh,
Devon TQ11 0LS

Telephone: 01364 643574
Facsimile: 01364 643982
Email: stoves@deanforge.co.uk

Dean Stoves has a policy of continuous development and reserve the right to change the specification on the stoves without further notice.

www.deanforge.co.uk



Dealer's Stamp

